

SNAPSHOT – FISCAL YEAR 2015

LABORATORY DIRECTED RESEARCH AND DEVELOPMENT

-
- Research Project Highlights
 - Awards & Recognition
 - Collaborations
 - Doctoral Research
-

FROM THE DIRECTOR



Dr. Mark Peters
Director, Idaho National Laboratory

March 2016

It is my pleasure to present “Snapshot – Fiscal Year (FY) 2015 Laboratory Directed Research and Development” (LDRD). This report highlights Idaho National Laboratory’s (INL’s) LDRD research projects.

Inside you will read about INL’s cutting-edge research, which builds our distinctive core capabilities and leadership strengths to help transform the world’s energy future, secure our critical infrastructure, and protect our citizens and soldiers.

LDRD projects align with INL’s strategic plan and benefit the U.S. Department of Energy, as well as an expansive sponsor base consistent with DOE and INL missions.

LDRD projects are selected on a competitive basis through rigorous peer review and management processes. This program contributes to building an environment of creativity—and scientific and technical excellence—at the Laboratory.

The program provides excellent professional development opportunities for our staff and helps attract promising young scientists and engineers. This continually refreshes our research staff and educates the next generation of energy workers. Many LDRD projects also support undergraduate and graduate students and provide for university and industry collaborations.

This vital research helps the world understand nuclear reactor risks, extend nuclear reactor life, and study the effects of storage and irradiation on nuclear fuel to improve performance, safety, and security. It also helps us better understand how to produce the clean energy needed to power our future—and integrate this energy into the grid—while ensuring global, national, and homeland security by protecting critical infrastructure and making it more resilient to cyber attacks.

Over the years, enhanced understanding and innovation resulting from LDRD projects have led to new research programs; recognition through awards, publications, and patented inventions; as well as new research tools, instruments, and capabilities at the Laboratory. The LDRD Program is a key component of INL’s ability to deliver its mission.

I am proud of the accomplishments and opportunities that INL’s LDRD Program provides in proving advanced research and development concepts to fulfill current and future mission needs.

A handwritten signature in black ink that reads "Mark Peters". The signature is fluid and cursive, with a large initial "M" and "P".

On the cover

Through a better understanding of the geomechanics of micropillars milled into shale samples such as this one, researchers can engineer methods to increase liquid and gas extraction from nanopores in shale. More on page 16.

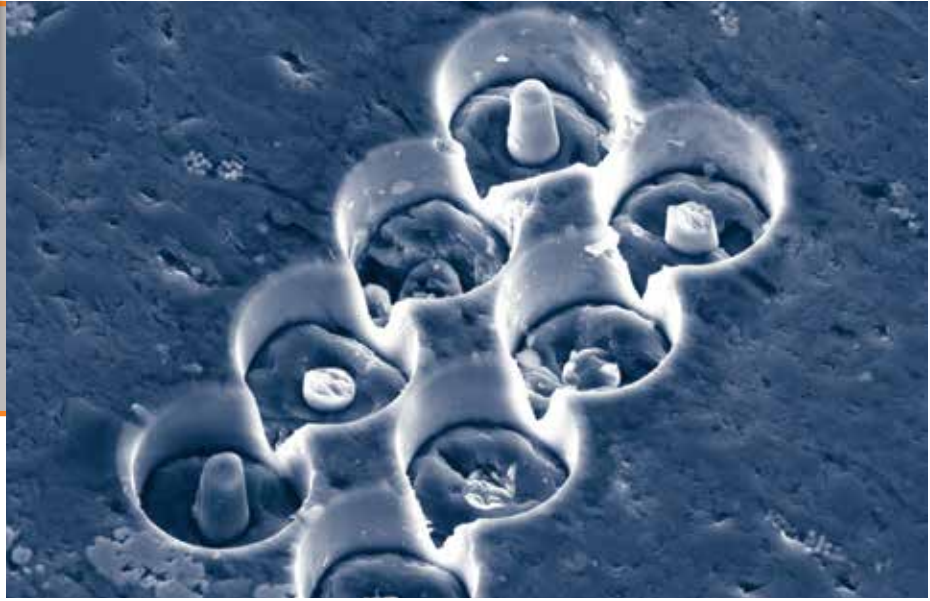

TABLE OF CONTENTS

Prepared by Idaho National Laboratory,
Idaho Falls, Idaho 83415.

Managed by Battelle Energy Alliance, LLC
for the U.S. Department of Energy
under contract DE-AC07-05ID14517.

Introduction:

Mission and metrics of INL's LDRD Program 2

Research Project Highlights:

Brief descriptions of LDRD projects spanning the breadth
of INL's research and development objectives 4

Awards & Recognition:

LDRD researchers honored in FY 2015 22

Collaborations:

Overview of LDRD collaborations with universities, industry, and
national laboratories. 24

Supporting INL Doctoral Research:

LDRD projects that supported doctoral research in FY 2015 25

Interns and Postdoctoral Fellows:

Interns and postdoctoral fellows involved in FY 2015 LDRD projects 25

This report was prepared as an account of work sponsored by an agency of the United States Government. Neither the United States Government, nor any agency thereof, makes any warranty, express or implied, or assumes any legal liability or responsibility for the accuracy, completeness, or usefulness of any information, apparatus, product, or process disclosed, or represents that its use would not infringe privately owned rights. Reference herein to any specific commercial product, process, or service by trade name, trademark, manufacturer, or otherwise does not necessarily constitute or imply its endorsement, recommendation or favoring by the United States Government or any agency thereof. The views and opinions of authors expressed herein do not necessarily state or reflect those of the United States Government or any agency thereof.

INTRODUCTION

INTRODUCTION

This report provides a sampling of the Laboratory Directed Research and Development (LDRD) Program highlights for Idaho National Laboratory (INL) in Fiscal Year (FY) 2015.

LDRD is a relatively small but vital U.S. Department of Energy (DOE) program that allows INL to select a limited number of research and development (R&D) projects for the purpose of maintaining the scientific and technical vitality of INL, enhancing INL's ability to address future DOE missions, foster creativity and stimulate exploration of forefront science and technology, serve as a proving ground for research, and support high-risk, high-value R&D. Through LDRD, INL is able to improve its distinctive capability and enhance its ability to conduct cutting-edge R&D for its DOE and Strategic Partnership Program sponsors.

The LDRD Program proves its value each year through new programs, intellectual property, patents, copyrights, national and international awards, and publications. It also provides a means to feed the science and technology pipeline with scientists and engineers through undergraduate and graduate internships, postdoctoral assignments, and doctoral candidates.

BENEFITS OF LABORATORY DIRECTED RESEARCH AND DEVELOPMENT

INL consistently realizes significant benefits from the LDRD Program. The FY 2015 metrics are shown below.

FISCAL YEAR 2015 LDRD METRICS

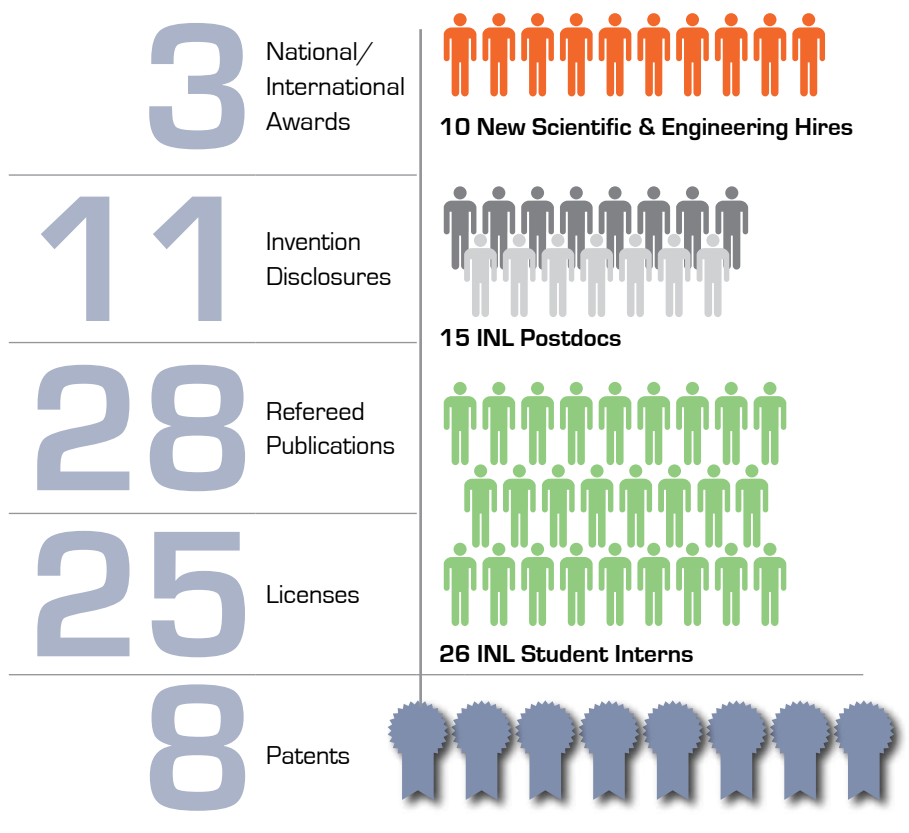

INL's diverse LDRD portfolio explores scientific and engineering concepts to support DOE's Office of Nuclear Energy, the broader DOE, and this nation's research, development, demonstrations, and deployment of nuclear energy, clean energy, and security.

SNAPSHOT – FISCAL YEAR 2015

LABORATORY DIRECTED RESEARCH AND DEVELOPMENT

FISCAL YEAR 2015 LDRD PROGRAM STATISTICS

18,228
[dollars, K]

TOTAL LDRD PROGRAM
COST

81
[projects]

TOTAL LDRD PROJECTS

750
[dollars, K]

LARGEST PROJECT
ALLOCATION

25
[dollars, K]

SMALLEST PROJECT
ALLOCATION

131

STAFF MEMBERS SUPPORTED
BY LDRD FUNDING

50%

LDRD HOURS CHARGED
BY NEW STAFF

REPORT ORGANIZATION

This report is a “snapshot” of research highlights that exemplify the diversity of scientific and engineering research performed at INL, awards and recognition resulting from LDRD funding, and collaborations using LDRD funding.

As a supplement to this publication, the comprehensive LDRD 2015 Annual Report^a contains summaries of all 81 LDRD projects funded in FY 2015, including a general description of each project, a summary of the scientific or technical progress achieved during the life of each project, a brief statement describing how each project benefited the DOE and National Nuclear Security Administration missions, and relevant peer-reviewed publications and presentations. The LDRD 2015 Summary Annual Report also includes appendices (an author index and project relevance to DOE program offices) that may be useful to readers.

^a Available online at www.inl.gov/LDRDINL.

THE LDRD PROCESS AT IDAHO NATIONAL LABORATORY

Each year, projects are selected for inclusion in the LDRD Program through a proposal process. To select the best and most strategic of the ideas submitted, the associate laboratory directors responsible for the various mission areas establish committees for the focus area to review new proposals and associated ongoing projects. The committees are staffed by senior research and technical managers who are subject matter experts and have no conflict of interest regarding the proposed projects.

Proposals for project funding for both the Strategic Initiatives R&D Fund and University Partnership Fund undergo two rounds of review. In the first round, the committees evaluate short preliminary proposals and select the most promising for development into full proposals. In the second round, the committees review the full proposals, as well as ongoing projects that are requesting second- or third-year funding. After the reviews are completed, the committees provide funding recommendations to the associate laboratory directors, who in turn present the recommendations along with their input to the Deputy Laboratory Director for Science and Technology, who develops an overall funding strategy and provides approvals for the investment. All projects selected for funding also receive concurrence from the DOE Idaho Operations Office.

PROJECT HIGHLIGHTS

RESEARCH PROJECT HIGHLIGHTS

Mass Spectrometry of Nanodroplets for Measuring Radioactive Samples

Over the past several years, electrospray ionization (ESI)-mass spectrometry (MS) has been invaluable for characterizing the effects of radiation on solvent-extraction systems used in nuclear fuel cycle separations. ESI functions by spraying droplets at a sampling aperture, transferring the important chemicals into the gas phase where they can be analyzed by the MS. In ESI-MS, most of the sample solution is deposited on the outside of the aperture, where it constitutes radioactive contamination. Here,

mass spectra of single, nanoliter-sized droplets are acquired one droplet at a time. This approach greatly reduces levels of radioactivity encountered when conducting an analysis and enables detailed investigations of the chemistry of solutions generated by nuclear fuel recycling processes (Project 13-039).

An INL intern aids in research to reduce radioactivity levels encountered during nuclear fuel analysis.

Close-up view of the capillary used to generate charged droplets, aligned with the sampling aperture cone of an ESI-MS instrument.





Replacing Empirical Models

The properties of materials, physical and mechanical, are determined by the collective and cooperative behavior of their atomistic structure. These properties are usually approximated by empirical models in nuclear fuel performance codes such as MOOSE, BISON, and MARMOT at engineering scales. But these empirical models are only valid for the data ranges generated in experiments, so the use of these empirical models outside of their bounds usually yields unreliable results. To be more predictive, this project aims to develop concurrent models, starting from the atomistic scale all the way to the engineering scale, replacing currently used empirical models. The outcome of this research will improve the predictive modeling of radiation damage in nuclear fuels and will help in the design of advanced fuels and nuclear materials (Project 13-050).

Modeling of microstructural behavior in reactor cladding that becomes brittle during storage (upper left). Simulated solidification of a metal crystal from liquid using the MARMOT code (left).

Nuclear Fuel Storage Integrity

During nuclear reactor operation, an oxidation process within the fuel's protective cladding creates hydrides. Hydrides do not significantly impact the performance of modern reactors but can lead to the cladding becoming brittle and cracking during long-term storage. This project is combining modeling with experimental work to predict hydride orientation under dry storage conditions with an emphasis on the fundamental mechanisms that govern microstructural behavior based on local stress states. Understanding this phenomenon is of great interest to entities that include the DOE, the Electrical Power Research Institute, reactor vendors, and utilities (Project 13-032).

Predicting hydride orientation under dry storage conditions is of great interest to entities that include the DOE, the Electrical Power Research Institute, reactor vendors, and utilities.

RESEARCH PROJECT HIGHLIGHTS

Ensuring Compliance with Nonproliferation Commitments

U.S. and international organizations use isotope ratio measurements to ensure nuclear energy facilities are operating in compliance with nonproliferation treaty commitments. This project is providing the scientific chemical basis for isotope ratio measurements at an ultratrace level while increasing accuracy and lowering detection limits. Transitioning to this method of measuring isotope ratios will allow the U.S. to make more informed decisions regarding the nonproliferation status of international nuclear energy programs at a substantially reduced cost compared with current methods and will advance the DOE's nuclear nonproliferation mission [Project 13-060].



Societal Safety Goal

The U.S. Nuclear Regulatory Commission's safety goals are conceived as high-level statements on safety philosophy and the role of safety/cost tradeoffs in the commission's decisions. The current safety goals address adverse health consequences to individuals from exposure to radiation as a result of accidents. Radiological consequences of nuclear accidents are expected to be low, partly because people are evacuated and relocated. But evacuation and relocation can cause significant societal disruption, and this consequence is not explicitly addressed by existing goals. This LDRD project studied the formulation of an additional [societal] safety goal to address societal disruption. It was concluded that a goal metric capturing the competition between disruption and radiological consequences would be a useful aid to decision-making [Project 13-095].

INL researchers seeking ways to measure isotope ratios at ultratrace levels, which will help ensure compliance with nonproliferation treaties.

Improving Oxide Reactor Fuel

INL researchers study the microstructure and radiation effects on the thermal conductivity of oxide fuel using a novel measurement technique and complementary computer modeling. Grain boundary (GB), which is the microscopic interface between two grains in polycrystalline material, could affect the heat transfer, depending on the type of GB. Atomistic modeling of the thermal transport is conducted to compare the results directly with experiments. Specifically, the following objectives are to be accomplished: (a) determine grain GB thermal resistance for different types of GBs in unirradiated materials to investigate how specific GB structure affects the thermal transport; (b) investigate the thermal resistance of GBs with fission-gas implantation; and (c) determine thermal conductivity degradation at different irradiation temperatures. Data from successful completion of this project will be helpful for advanced fuel development (Project 13-105).

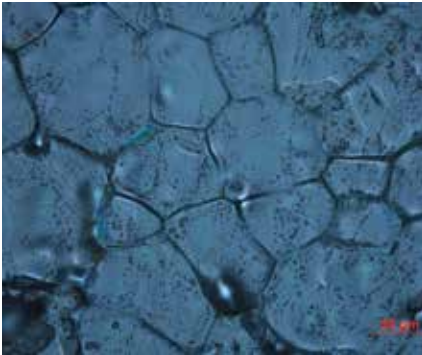

Grain boundaries, which could hold clues about heat transfer in nuclear fuels (top). Studying the microstructure of oxide fuel to help develop advanced nuclear fuels (bottom).

Multiphysics Reactor Simulator

Experimental reactors are used to evaluate nuclear fuel performance under reactor operating conditions, and the data are used to improve fuel design. But today's budget constraints limit experimental measurements, and the use of existing commercial reactors for data collection can be problematic for proprietary reasons. So INL researchers are developing a prototypic multiphysics capability for full reactor simulation. This will provide the means to substantially reduce the cost of experimentation by providing rigorous experiment design capabilities through simulation. The capability is being evaluated using INL's Advanced Test Reactor and Transient Test Reactor. The capability will also be extended to light-water reactors and next-generation reactor designs to improve reactor performance, safety, and economics (Project 13-115).

RESEARCH PROJECT HIGHLIGHTS

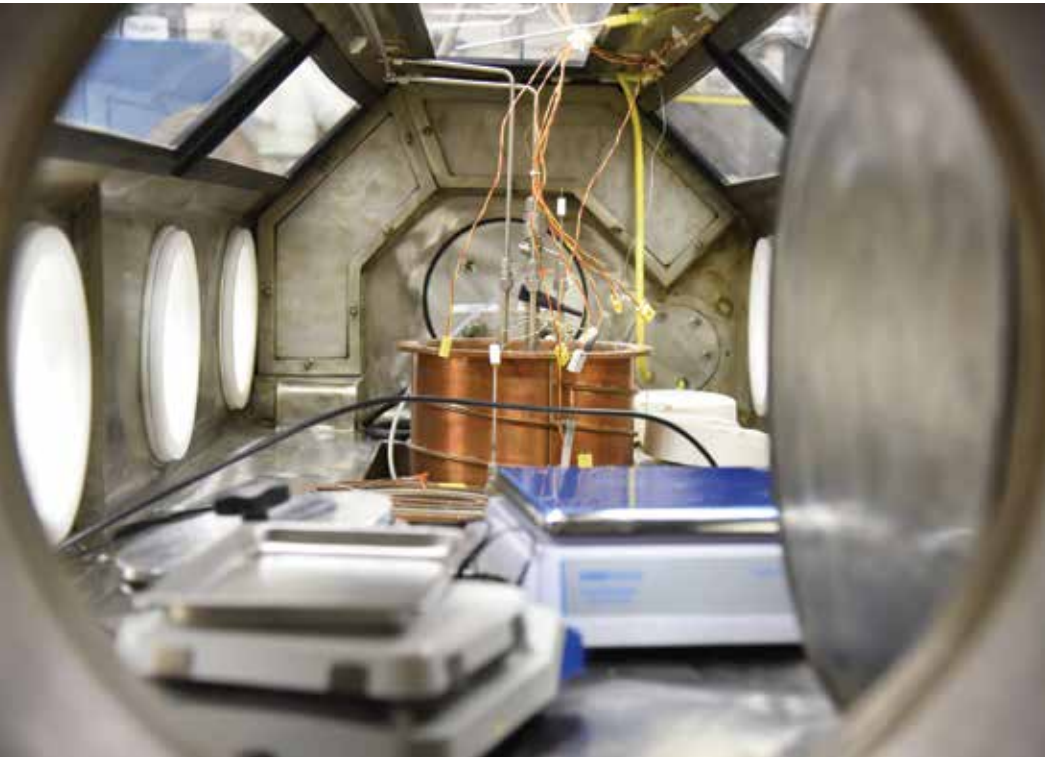

A glovebox outfitted to support research activities at the Advanced Reactor Technology Integral System Test facility.

Advanced Reactor Component Testing

Generation IV nuclear energy technologies are defined by safety, economic, technical, and environmental advances. Components relevant to these reactors require performance and integrity evaluation at prototypical conditions. The Advanced Reactor Technology Integral System Test (ARTIST) capability, conceived and designed with this LDRD project, provides this physical test platform. It will allow energy-systems researchers to advance and integrate emerging technologies, such as advanced small modular reactors, high-temperature heat exchangers, hybrid energy systems, and dynamic grid energy storage (Project 14-009).

Protecting Nuclear Fuel Pins in Storage

Nuclear fuel must not make direct contact with the coolant inside a reactor vessel because of the potential for radioactivity to be released into the environment. So cladding is used to surround the fuel as a protectant. Formation of hydrides in zirconium-based cladding leads to it becoming brittle and has been identified as a critical material-science issue affecting the integrity of fuel pins in light-water reactors during storage. While hydrides have been widely characterized by experiments, the transport of hydrogen and the mechanisms for hydride formation have not been fully understood. Using atomistic-scale modeling tools, the objectives of this project are to (a) investigate hydrogen diffusion and segregation and (b) explore the mechanisms for hydride nucleation in zirconium. The research results and data collected from the atomistic scale will be useful for upper-scale modeling of hydride formation and reorientation that may occur during used fuel disposition (Project 14-026).

Real-Time Geometry Measurements during Reactor Materials Testing

To improve nuclear reactors, new materials are considered for fuel, cladding, and structures. But irradiation may change materials in unwanted ways, so the materials must be tested before being used in working reactor systems. In the U.S., the only method available for detecting geometry changes is by irradiating a sample for a specified period in a test reactor and then

removing it for evaluation. Removing, examining, and returning irradiated test samples for each measurement makes this approach expensive. Such techniques also provide limited data, and handling may disturb the phenomena of interest. Consequently, in-pile detection of geometry changes during irradiation is needed. This project will enable INL's Advanced Test Reactor to use test rigs capable of detecting in-core, real-time changes in the length and diameter of fuel rods and material samples [Project 14-010].

Testing of rigs that may allow in-core, real-time detection of changes in fuel rods and material samples.



RESEARCH PROJECT HIGHLIGHTS

Modeling Nuclear Fuel during Accidents

Reliably predicting the behavior of nuclear reactor components during abnormal events is essential from both a safety and an economic standpoint. State-of-the-art computational tools can help. However, empirical models often do not exist for the high

BISON team members in a visualization laboratory.

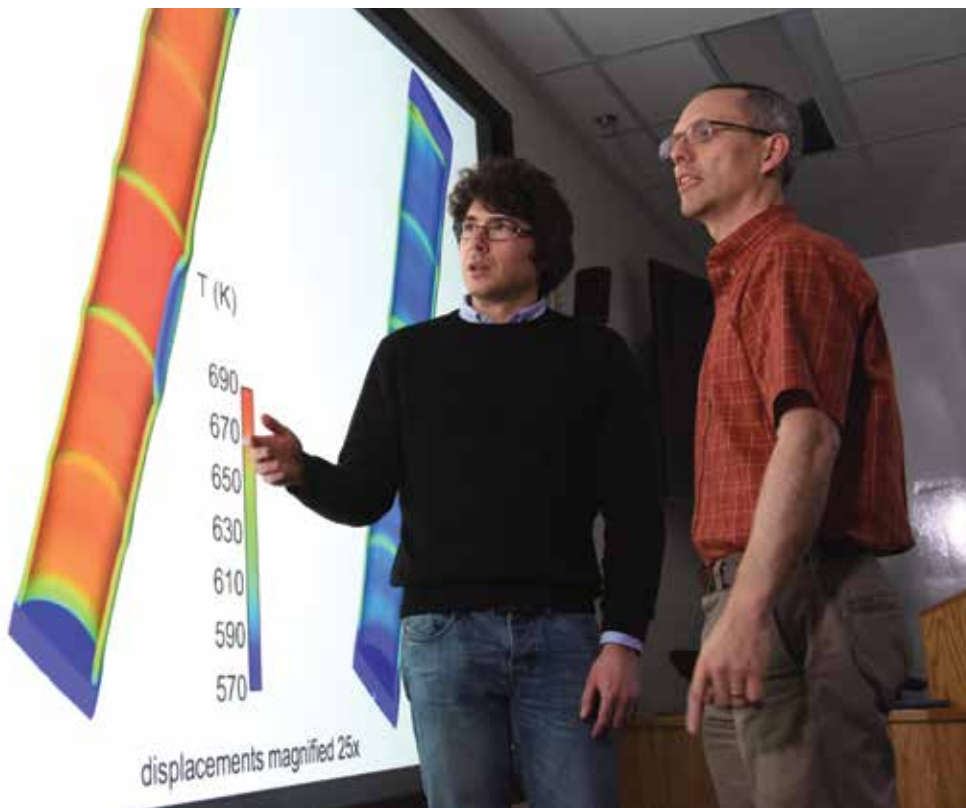

Prototypical fuel pellet that was sectioned for microscopy.



temperatures experienced during accidents, and uncoupled simulations are unrealistic during all operating conditions. It is important to replace these approaches with more predictive codes based on multidimensional, fully coupled multiphysics methods. INL's fuel performance code, BISON, meets these basic characteristics, offering high potential for the improved computational analysis of fuel rod behavior during accidents. During this LDRD project, novel multiphysics models to describe nuclear fuel rod behavior during accidents were developed, implemented, and validated within the BISON code (Project 14-031).

Accident Tolerant Fuel Fabrication by Spark Plasma Sintering

Nuclear engineers have long been interested in fuels with enhanced accident-tolerant characteristics that lengthen the grace period if reactor cooling is lost. Fuel pellets composed of a composite matrix of uranium di-silicide (U_3Si_2) and uranium mononitride (UN) are of interest as one such fuel form for light-water reactors. Preliminary results of this LDRD project successfully demonstrated the feasibility of producing high-density, net-shaped composites of UN- U_3Si_2 via the spark plasma sintering process. The U_3Si_2 -UN fuel conducts heat more efficiently, increases the safety margin of the reactor, and may be able to be used in place of fuels in existing light-water reactors (Project 14-041).

Irradiation Effects in Uranium Dioxide

Understanding the impacts of how radiation affects uranium dioxide at the nanoscale can help engineers better respond to macroscale material challenges. This LDRD project is simulating the environment inside current and future reactors using ion and proton beams, as well as neutron irradiation via INL's Advanced Test Reactor. Research in FY 2015 compared and contrasted the uranium dioxide samples exposed to varied environments with actual used fuel samples. The work ultimately supports a more thorough understanding of nuclear fuel stability following irradiation and throughout extended fuel storage (Project 14-098).

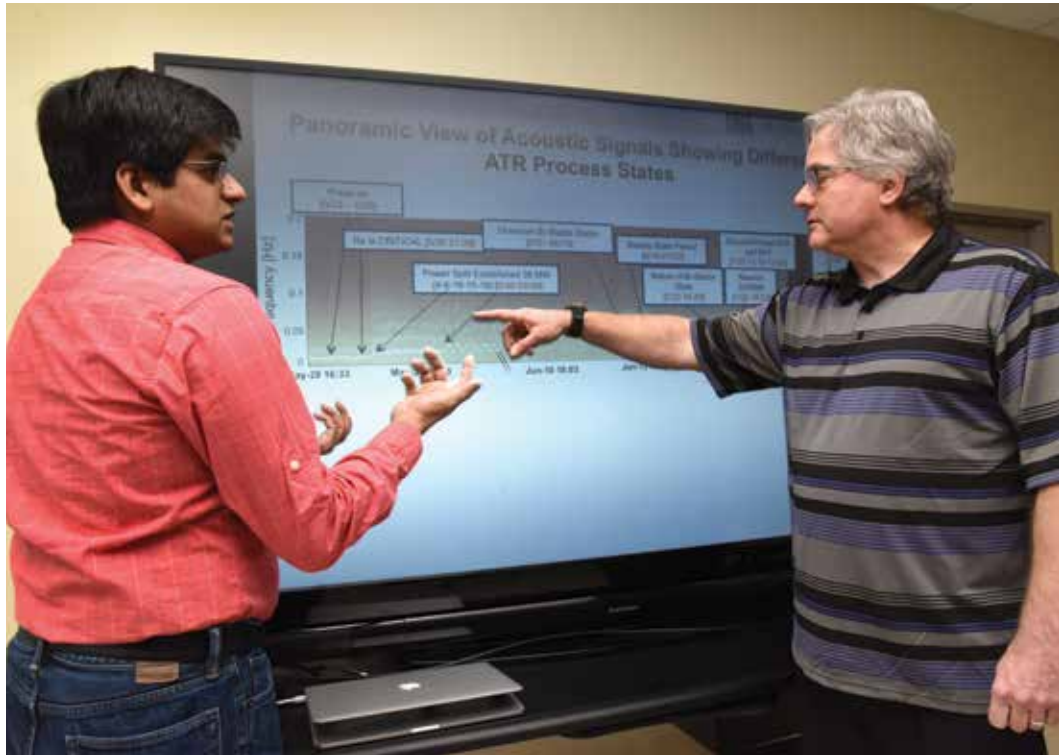

INL researchers developing techniques to analyze acoustic signals from reactor cores.

Even early detection of certain failures, degradation, and other diverse faults inside reactors is possible with proper techniques, with no impact on reactor safety or control systems.

Acoustic Monitoring of Nuclear Reactors

A nuclear reactor is a hostile environment for sensing and electrical communications. Still, the reactor core is amenable to acoustic communication. This project is focused on developing advanced signal-processing techniques to analyze acoustic signals from a reactor core. Listening to a reactor's intrinsic and extrinsic acoustic sources using acoustic telemetry is believed to enable an efficient, nonintrusive, in-pile measurement of reactor vitals such as temperature, axial extension, fission gases, neutron flux, and gamma flux when coupled with advanced signal processing algorithms. Even early detection of certain failures, degradation, and other diverse faults inside reactors is possible with proper techniques, with no impact on reactor safety or control systems. Successful completion of this research will enable online in-pile monitoring of reactor vitals, and improve the quality and capability to analyze in-pile data to support modeling and simulation research associated with reactor materials and fuels. These outcomes would benefit current and next-generation reactor concepts (Project 15-040).

RESEARCH PROJECT HIGHLIGHTS

Improving Seismic Simulation

To help nuclear facilities resist the potentially damaging effects of earthquakes, engineers employ national consensus codes and standards requiring the use of computer codes that are limited to simulation of low- to moderate-magnitude earthquakes. But these codes cannot accurately simulate larger earthquake ground motions. To improve seismic simulations, researchers are using an INL-developed modeling framework, MOOSE, to develop a capability that numerically propagates simulated large-magnitude earthquake waves through soil. This research will allow nuclear facility owners to numerically evaluate a facility's response to large-magnitude earthquakes, enabling these owners to make risk-informed decisions about how to mitigate the effects (Project 15-023).

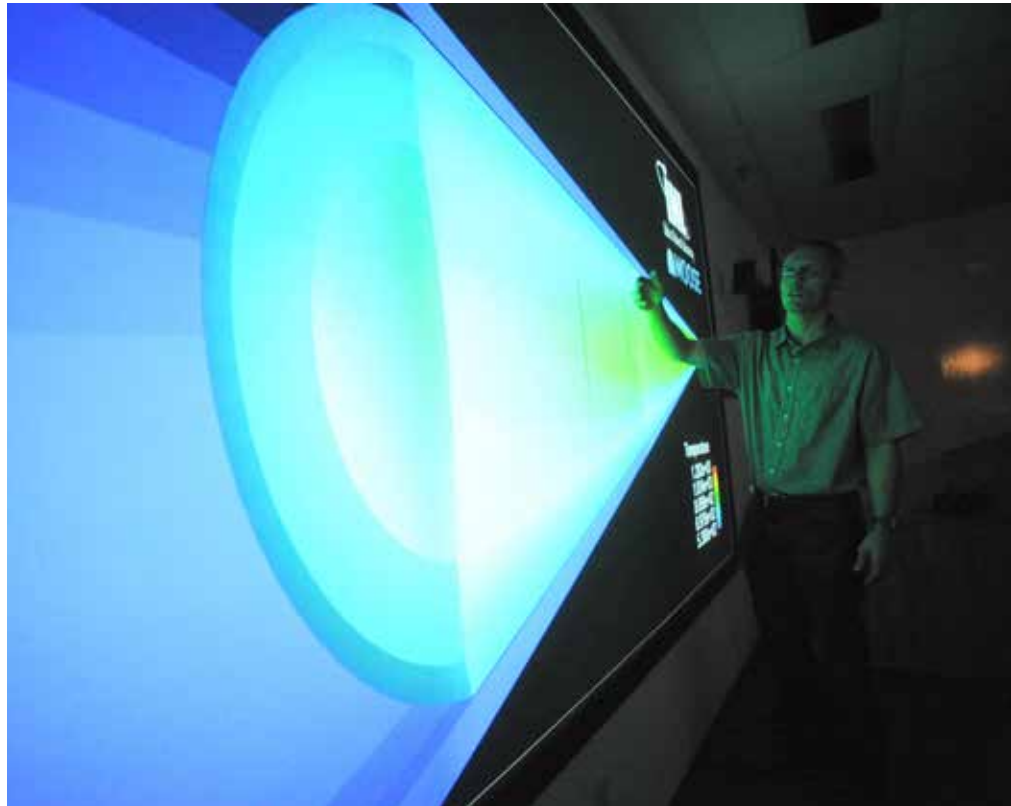

Enhancing MOOSE-based computer codes.

Enhancing MOOSE

This LDRD project enhanced the MOOSE-based computer codes' simulation capabilities in three areas. The first area enhanced the MOOSE-based RAVEN/RELAP-7 computer codes' capabilities to simulate physical components by connecting the codes with the digital instrumentation and control systems of the distributed test facility at The Ohio State University. The second area enhanced the modeling and release of fission products and material corrosion. The interactions between fission products and primary coolants, as well as a system-level corrosion/precipitation model obtained, can be incorporated into MOOSE-based BISON and RELAP-7 codes, respectively, to enhance MOOSE capabilities for coolant-fuel interaction. The third area focused on the development of the thermal nonequilibrium drift-flux model that will help address the modeling challenges for the conventional drift-flux model when treating thermal nonequilibrium phenomena frequently encountered in light-water reactors but will reduce the computational and model difficulties associated with the detailed two-fluid model (Project 15-141).

Thermal Conductivity in Nuclear Fuels

The ability of nuclear fuels to conduct heat governs the conversion of fission-generated heat to electricity. As a result, thermal conductivity is an important parameter in nuclear reactor design and safety. To fully understand and reliably model thermal conductivity, it must be studied over a broad temperature range because different radiation-scattering mechanisms affect thermal conductivity at different temperatures. The main goal of this project is to develop a new way, using the 3Ω (omega) method, to measure thermal conductivity of small samples of nuclear materials at temperatures from 2 K to 800 K. The data obtained will help researchers understand and develop new nuclear fuels, leading to

more efficient energy production and better security for the nation (Project 15-032).

Modeling of Integrated Energy Systems

Nuclear power systems are proposed as a means of offsetting the intermittent nature of power-generation sources such as the wind and sun. This project has made progress toward dynamic modeling of integrated energy systems—nuclear, wind, and solar—that could play a major role in future U.S. energy planning and development. In addition, this project is modeling potential electric and thermal energy storage systems integrated with nuclear systems, modeling anticipated transient behavior/response of subsystems, and assessing the

impact of aging and degradation of key components (e.g., valves) on system operation. Modeling capability such as this will aid the nation as it seeks to reduce environmental impacts through incorporation of low-carbon thermal and electric energy sources into existing power systems (Project 15-039).

Geothermal Modeling

INL is one of several sites that may host a major DOE facility designed to test enhanced geothermal system concepts and methods, which could lead to significant increases in energy production from geothermal sources. Through scientific study of the geologic and physical controls on temperature and geomechanical conditions in the eastern Snake River Plain, this project advances INL's goal of becoming a leader in enhanced geothermal system science and providing a geothermal system proving ground. The groundwater heat-transport modeling conducted as part of this project is an innovative means of examining geothermal heat flux variability that also provides feedback about groundwater flow parameters that are not easily obtained via other methods (Project 13-068).

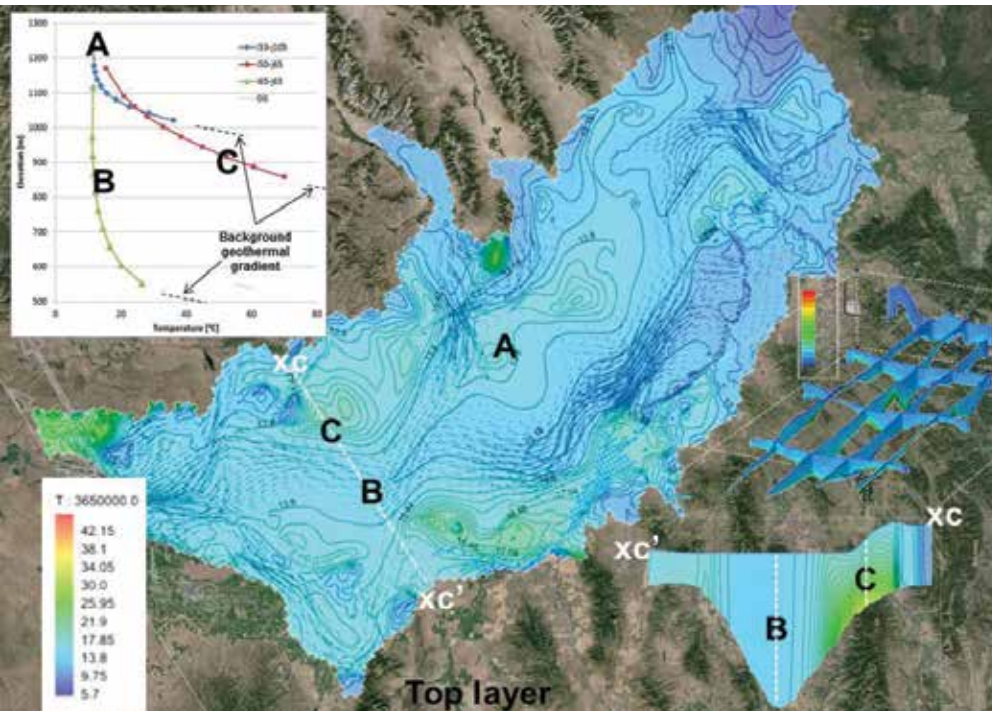

Temperature map of the bottom of the eastern Snake River Plain aquifer.

RESEARCH PROJECT HIGHLIGHTS

Dynamic Modeling, Co-Simulation, and Optimization of Hybrid Energy Systems

This project developed computational tools to enable the design, analysis, operation, and optimization of hybrid energy systems using models and advanced simulation, controls, and optimization techniques. Hybrid energy systems, which usually consist of two or more energy sources and products, are a promising architecture for addressing difficulties encountered when integrating clean energy technologies with existing power infrastructures. Integration challenges include high variability, uncertainty, and uncontrollability in energy production and consumption, high variability in component and configuration options, and grid instability arising from high levels of variable energy resources. Studies conducted using the computational tools developed under this project have investigated optimized industrial-scale energy systems, reliable and cost-effective energy solutions that provide electricity to meet grid demands with less energy storage, and new thermal and electrical energy options [Project 13-065].

Superalloys for Long-Term Service Applications

To fully realize the capabilities of advanced solar, nuclear, and fossil-fuel power systems, new materials that exceed the performance of the current state of the art must be developed. For high-temperature materials, INL researchers are studying unique nickel-based alloys with the capability to maintain their impressive strength for long periods in environments with temperatures that approach 1,000°C. The superalloys of interest have inherent long-term stability owing to specially tailored microstructures that make them ideal for extended service at the high temperatures necessary to extract maximum efficiency, enabling increased productivity in future energy generation [Project 14-078].



Researching alloys that maintain their strength for long periods in high temperatures.



Advancing Water Treatment Technology

This project is developing the essential materials for an INL-invented water treatment technology known as switchable polarity solvent forward osmosis. This technology addresses high-fouling and high-salinity solutions while achieving a high recovery of water and/or very concentrated solution. Once implemented at scale, this technology is expected to cost a fraction of existing water-treatment technologies and to be ideal for treating industrial waters. This technology addresses the interplay between (a) energy, which requires water for production and generation; (b) water, which requires energy to produce and treat; and (c) industry, which needs energy, water, and water-treatment methods in order to function [Project 14-079].

A researcher with a forward osmosis element that is part of an INL-invented water treatment technology.

RESEARCH PROJECT HIGHLIGHTS

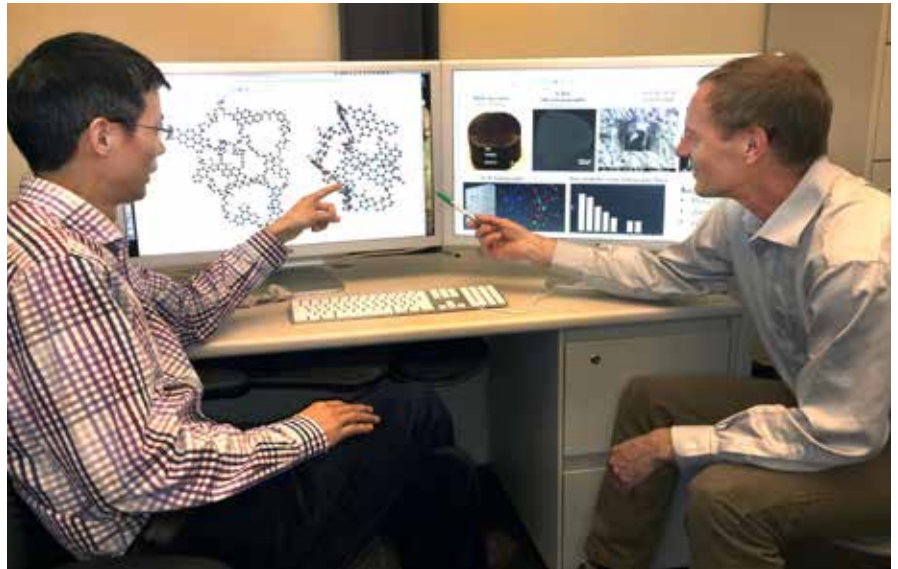

Molecular dynamics modeling (right).

Five-micron-diameter micropilars milled into a shale sample before (below) and after crushing (bottom) to understand how shale fractures at the microscopic scale.

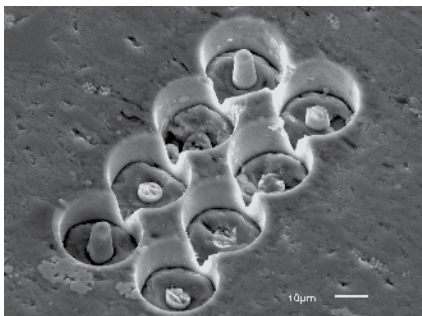
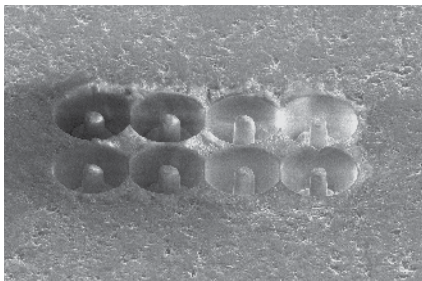

Seeking More from Shales

Organic-rich nanoporous shales contain most of the world's oil and possibly most of its natural gas resources. However, only a fairly small fraction of this oil and natural gas (typically about 5 and 20%, respectively) can be acquired using today's technology. The most important knowledge gap impeding improved acquisition of shale oil and shale gas is the lack of a fundamental understanding of the dynamics of fluids in organic-rich nanoporous shale. This project seeks to bridge the knowledge gap by integrating molecular dynamics modeling, electronic microscopy, and high-resolution x-ray imaging techniques to better understand the physics of fluids within organic nanopores where most of the hydrocarbons are trapped. This research also has important implications in using depleted gas

shale for geological sequestration of carbon dioxide and storage of radiotoxic wastes (Project 15-128).

Geographically Distributed Real-Time Power System Simulation

Real-time simulations of large-scale electric power networks are used to gain an understanding of the transient interaction of different components and smart grid technologies in electric grids up to microsecond timescale. This project is developing capabilities for geographically distributed real-time simulation of power networks using real-time simulators and interconnectivity between different locations. This connectivity will be used to conduct dynamic and transient analyses of large-scale power and energy systems, allowing future grids to be more reliable (Project 15-135).



Mitigating Solar Storm Effects on Power Grids

Solar storms cause geomagnetic disturbances (GMD) that can result in destabilized power grids, damaged power transformers, and overloaded transmission lines. To better understand and predict the effects of GMD on utility-scale power grids and related critical power system components, researchers developed and installed a system that records and measures the power-grid-related effects of GMD on the INL's 138-kV, full-scale power grid. Until this LDRD, utility companies relied on models and theories to help understand, detect, and mitigate the possible effects of solar storms. The ability to understand, predict, and mitigate geomagnetic-induced problems on INL's grid will assist in reliably defending electric grids (Project 13-118).

INL's full-scale electric power grid, which is being used to research the effects of geomagnetic disturbances on electric grids.

RESEARCH PROJECT HIGHLIGHTS

Energetic Material Ignition

Energetic materials, such as pyrotechnics and thermites, are used in many applications—for example, in fireworks and metal welding operations. These materials are useful and generally safe to handle, though accidental ignition can be catastrophic. This project is developing an approach to prevent energetic materials ignition from an accidental fire during storage or transportation. Additives to the energetic materials aim to automatically change the ability to

ignite from functioning normally to non-ignition when exposed to the prolonged conditions of an accidental fire. The project could enhance the safety of personnel in the U.S. Departments of Energy, Defense, and Homeland Security who routinely deal with energetic materials in physical security, emergency response, and material disposition (Project 14-035).

The project could enhance the safety of personnel in the U.S. Departments of Energy, Defense, and Homeland Security who routinely deal with energetic materials in physical security, emergency response, and material disposition.



Images of reactions of multiple mixtures of aluminum, copper-oxide particles, and experimental additives.



Detecting Nuclear Detonations

In support of the Comprehensive Nuclear-Test-Ban Treaty Organization, international investigators collect air samples in areas where nuclear detonations are suspected of occurring. Xenon-135 (Xe-135) found in such samples would be consistent with a recent nuclear detonation. But the short half-life of Xe-135 (about nine hours) makes detecting it in samples collected far from an analytical laboratory a logistical nightmare. Enter a new tool proposed by INL researchers. Because Xe-135 decays

to its daughter product cesium-135, which has a half-life of about 2.3 million years, this project is now exploring the potential of using cesium-135 as an indicator of a nuclear detonation. If successful, this project will provide an enhanced confirmatory tool for the nuclear nonproliferation community (Project 15-014).

Using a triple-sector mass spectrometer to explore use of cesium-135 as an indicator of nuclear detonations.

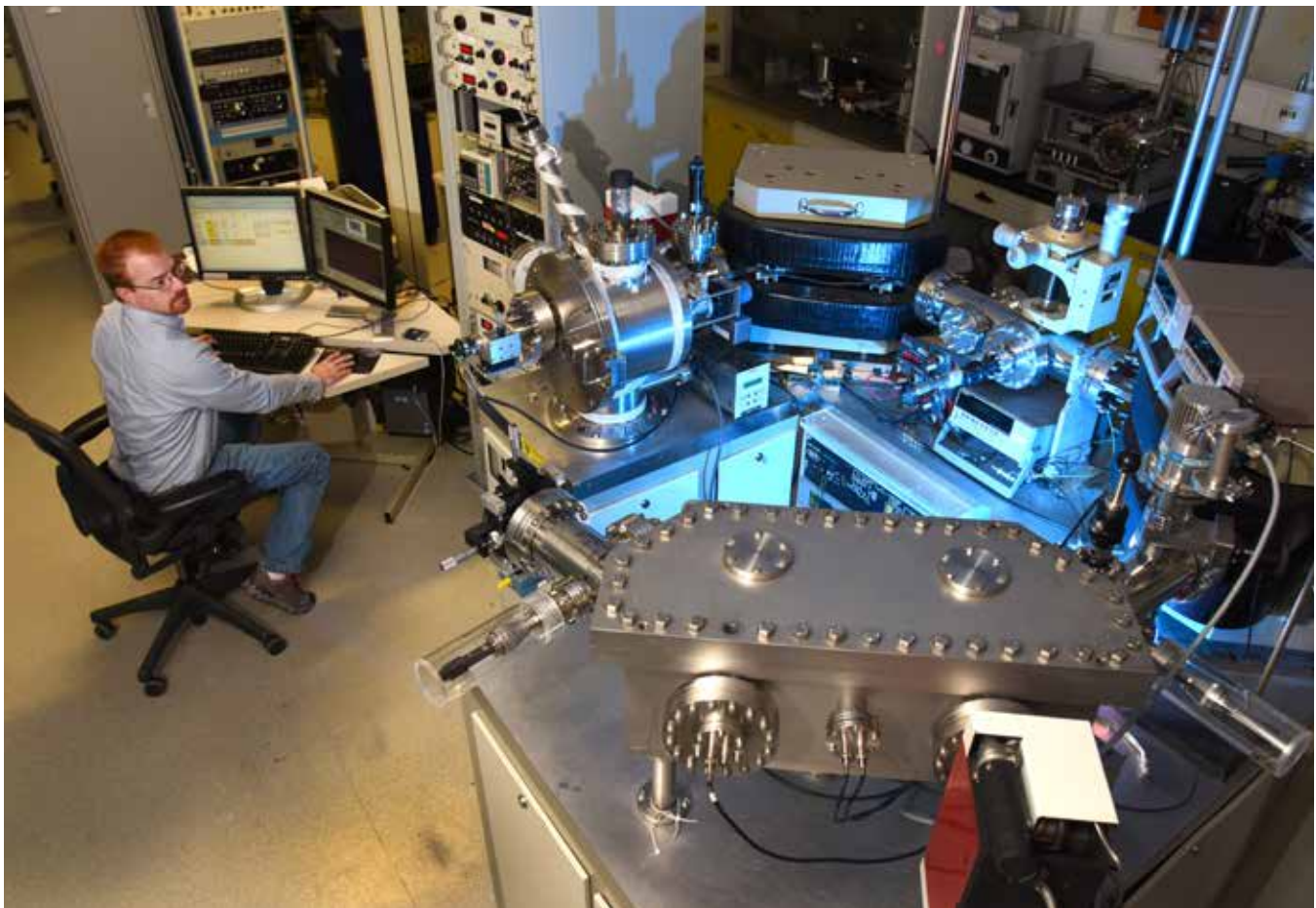

Protecting Industrial Control Systems

The U.S. depends on industrial control systems (ICS) to monitor and control its critical infrastructure. Due to U.S. dependence on ICS and the increasing threat to these systems from malware, proactive techniques are being developed to reduce the vulnerabilities that could be exploited by malicious entities. Concolic execution is a state-of-the-art, program-analysis technique used to detect software bugs and exploitable vulnerabilities. At its current level of development, concolic execution can only be used to analyze the software running on a single device. In contrast, ICSs are generally composed of multiple devices within a network, with each device running its own software. This research is extending concolic execution such that it can be applied to the software system of an ICS or multiple ICS (Project 15-096).

An ICS is a complex system composed of multiple layers of software applications and networked devices. Concolic execution for industrial control systems provides a methodology to discover bugs in such systems. For example, a bug in a critical flow loop is discovered by the analysis along the indicated red path through the logic of both devices' programs.

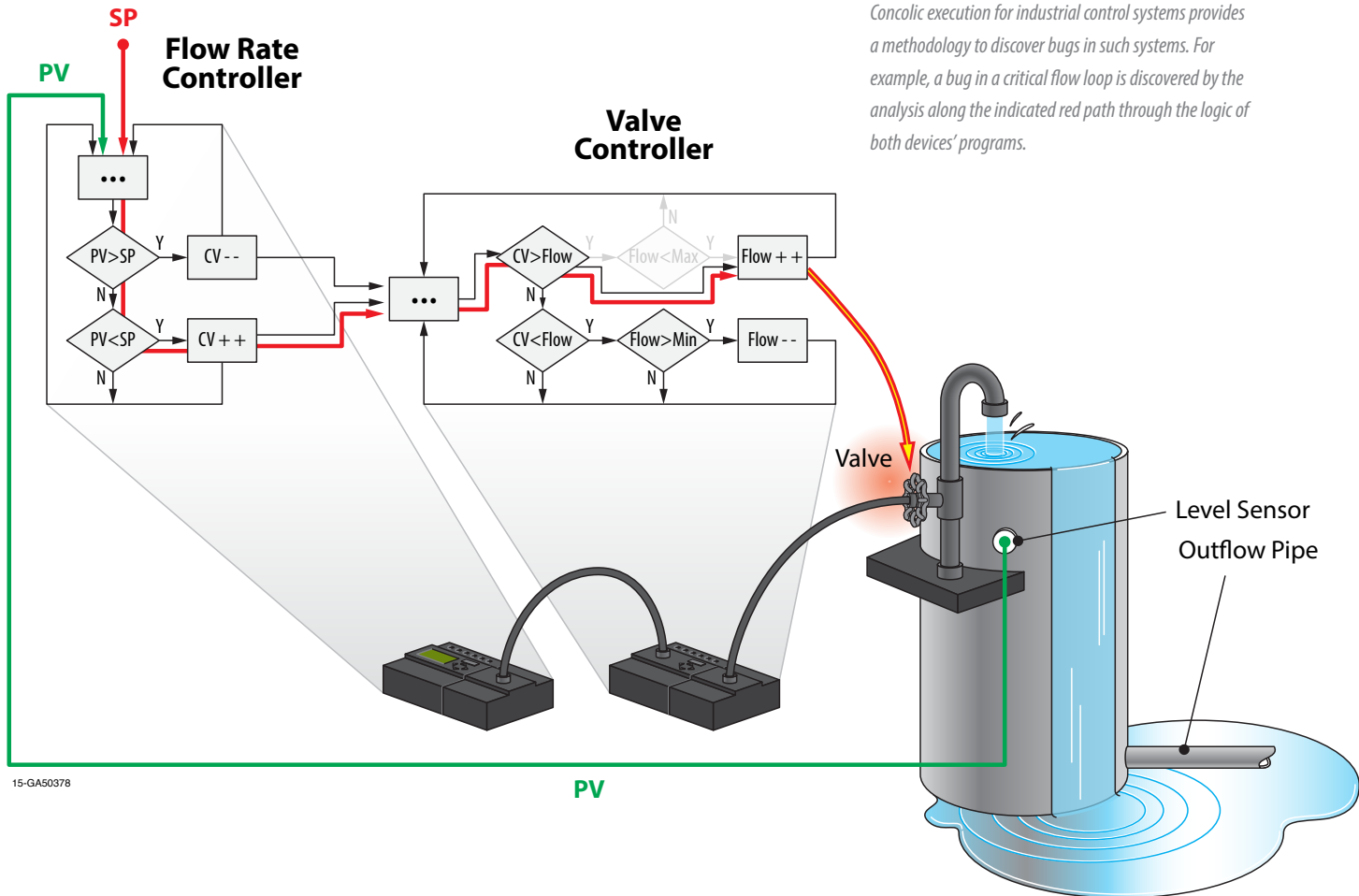

15-GA50378

PV

Next-Generation Security

Recent years have seen an explosion of research focused on cyber threats aimed at meeting the needs of an ever-evolving cyber landscape. To aid in this effort, INL researchers are blending the current concepts of behavioral economics with the analytical procedures used in law enforcement and the intelligence community to fill the gap in threat analysis. A goal of this work is greater understanding of how hackers interact, share information, approach problems, and use technology. Data collected and modeled from this research is also being used to develop a more comprehensive view of the personal motivations and thought processes of the cyber attackers. With this information in hand, indicators of a cyber attack can be recognized and shared to educate the next generations of cyber defenders (Project 15-111).

*Researchers in INL's Human Systems
Simulation Lab working to recognize
indicators of impending cyber attacks.*



AWARDS AND RECOGNITION



KRZYSZTOF GOFRYK

The INL researcher was selected by the DOE's Office of Science to receive its Early Career Research Program Award and significant research funding during the next five years. He was recognized for his research in actinide materials under extreme conditions. This research will be aided by his LDRD project, which focuses on a new method for measuring thermal conductivity in nuclear materials (Project 15-032).

SHANNON BRAGG-SITTON

The senior nuclear engineer received the 2014 Mary Jane Oestmann Professional Women's Achievement Award from the American Nuclear Society. She was honored for her exceptional contributions to the DOE's Light Water Reactor Sustainability Program and nuclear hybrid energy programs (Project 15-039).



SNAPSHOT – FISCAL YEAR 2015

LABORATORY DIRECTED RESEARCH AND DEVELOPMENT

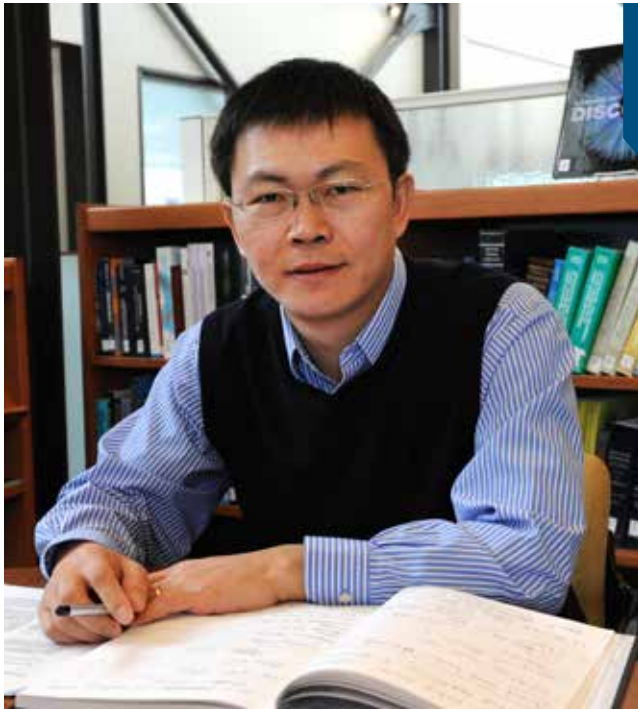

XIANMING (DAVID) BAI

The staff scientist was recognized with a Young Leader Professional Development Award from The Minerals, Metals & Materials Society for his research on nuclear materials. These awards recognize early career individuals, under the age of 40, for their potential as future leaders within The Minerals, Metals & Materials Society and the materials and engineering community it serves (Project 13-105).

AARON WILSON

The research chemist was honored with an Idaho Falls Chamber of Commerce Distinguished under 40 Award. Each year, the Greater Idaho Falls Chamber of Commerce recognizes 10 hard-working young professionals in the southeastern Idaho area who have gone above and beyond in their careers, community, and education. He has been the principal investigator on several projects in materials chemistry and chemical separation processes, including an LDRD project that pioneered the switchable polarity solvent forward osmosis water treatment system (Project 14-079).



COLLABORATIONS

COLLABORATIONS

Of the 81 LDRD projects funded in FY 2015, more than half (46 projects) involve university collaborators. These projects supported 18 undergraduate students and master's degree candidates, eight doctoral candidates, and 14 postdoctoral researchers. Collaborators on LDRD projects also included 10 industry partners and two national laboratories. Collaborations among university researchers, national laboratory researchers, and industry foster creativity and opportunities to help find solutions to national challenges. Such collaborations also support DOE objectives for nurturing the next generation of scientists and engineers.

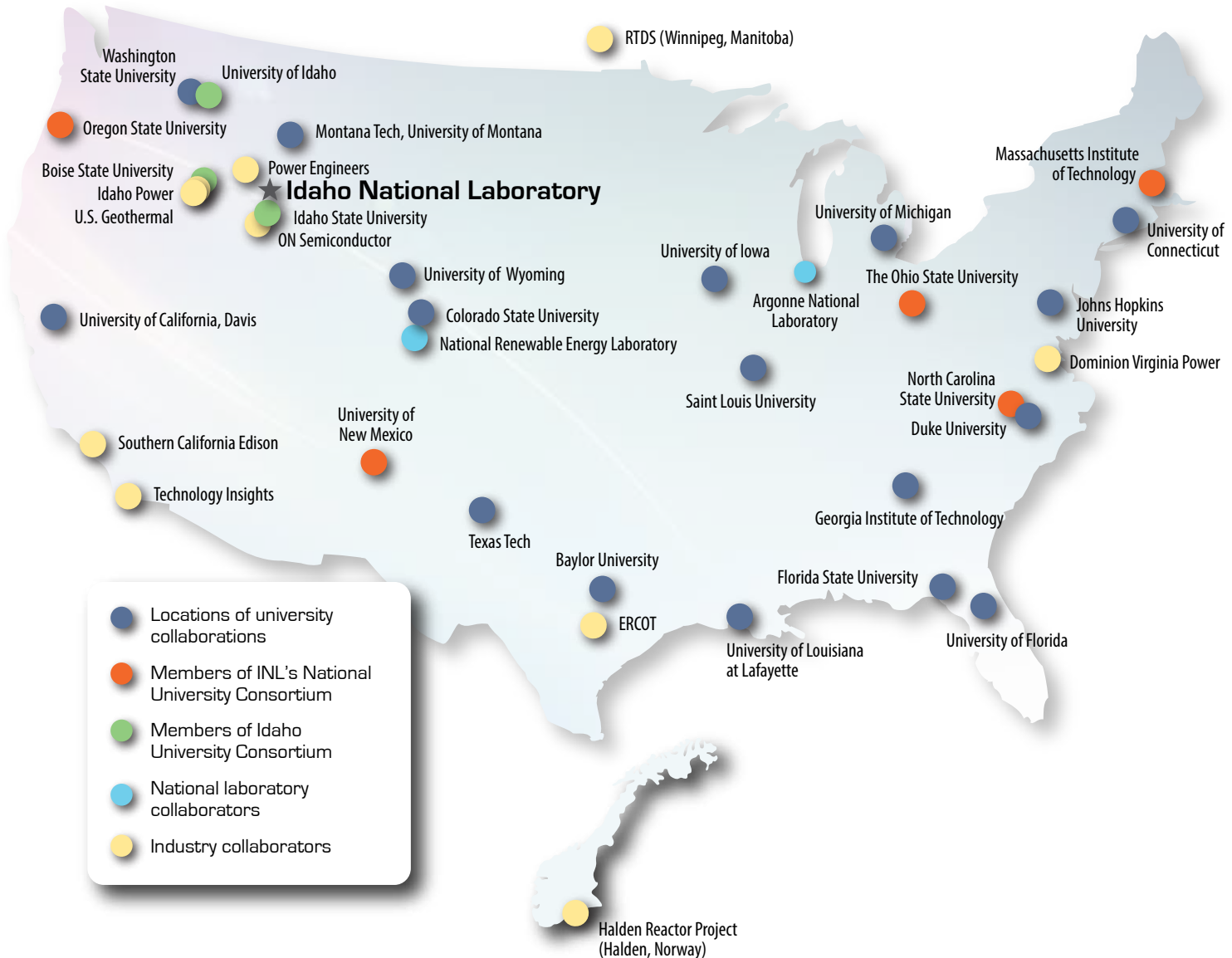

SUPPORTING INL DOCTORAL RESEARCH

The LDRD project, “End-to-End Dynamic Program Analysis for Industrial Control Systems with Concolic Execution Program,” is supporting the doctoral research of **Craig Miles**. This project is highlighted on page 20 (Project 15-096).

Derek Gaston’s doctoral research, “Development of a Multiphysics Algorithm for Analyzing the Integrity of Nuclear Reactor Containment Vessels Subjected to Extreme Thermal and Overpressure Loading Conditions,” is supported by the LDRD Program (Project 14-104).

The LDRD project, “Development of Bayesian Uncertainty Quantification Tools for Use in Complex Modeling and Simulation Code Validation,” is supporting the doctoral research of **Doug Burns** (Project 15-143).

The LDRD project supporting **Joseph Yurko’s** doctoral research is “Multivariate Calibration of Complex Simulation Codes Using Disparate Types of Evidence” (Project 14-038).

Justin Coleman’s LDRD project, “Development of Stochastic 3D Soil Response Capability in MOOSE to Provide Design and Beyond-Design-Basis Seismic Motions for Nuclear Facilities,” is supporting his doctoral research. His project is highlighted on page 12 (Project 15-023).

The LDRD project, “Use of Linear Variable Differential Transformer (LVDT)-Based Methods to Detect Real-Time Geometry Changes during Irradiation Testing,” is supporting the doctoral research of **Kurt Davis**. His project is highlighted on page 9 (Project 14-010).

Ryan Hruska’s LDRD project, “All Hazards Critical Infrastructure Knowledge Framework,” is supporting his doctoral research (Project 14-093).

The LDRD Program is supporting **Tony Koonce’s** doctoral research through a project called “Simulation Based Analysis of Procedures and Accident Management Guidelines” (Project 15-013).

INTERNS AND POST-DOCTORAL FELLOWS

Postdoctoral fellows:

Birenda Adhikari
Jun Chen
Wenbo Du
Colt Heathman
Wen Jiang
Yusheng Luo
Subhashish Meher
Manish Mohanpurkar
Sebastian Schunert
Swetha Veeraraghavan
Bradley Wahlen
Congjian Wang
Yidong Xia
Jun Soo Yoo
Su Jong Yoon

Interns:

Jacob Bair
Matthew Brown
Alexander Douglass
Shiloh Elliott
Kamshad Eshghi Esfahani
Andrew Franklin
Jan Goral
Hans Hammer
Md Hossain
Joshua Hrisko
Yile Hu
Vincent Laboure
Ren Liu
Emily Mariner
Justin McAlister
Junwei Meng
Julian Osorio Ramirez
Manas Pathak
Gorakh Pawar
Andrew Petti
Jeffery Porter
Daniel Shy
Paul Talbot
Yuran Zhang
Jing Zhou

The Laboratory Directed Research and Development Program at Idaho National Laboratory advances cutting-edge research and helps develop strategic capabilities that span the Lab's nuclear energy, clean energy deployment, and security mission areas.



WWW.INL.GOV/LDRDINL